

- NOTES:
 1. MATERIAL: SEE TABLE
 2. FINISHES: SEE TABLE
 3. MATES WITH: INDUSTRY STD. BAYONET LOCKING USB TYPE A
 4. MAX PANEL THICKNESS .10

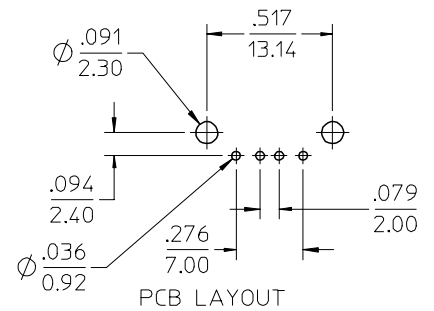
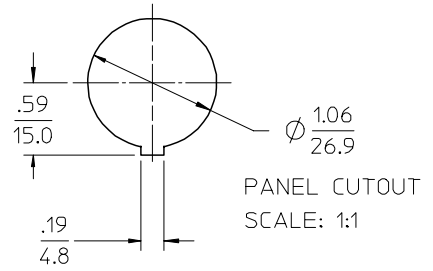
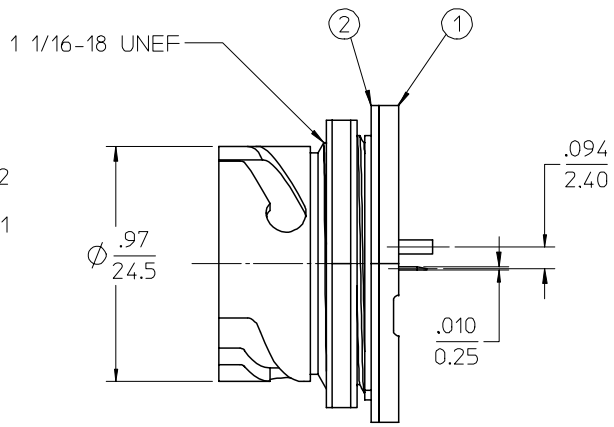
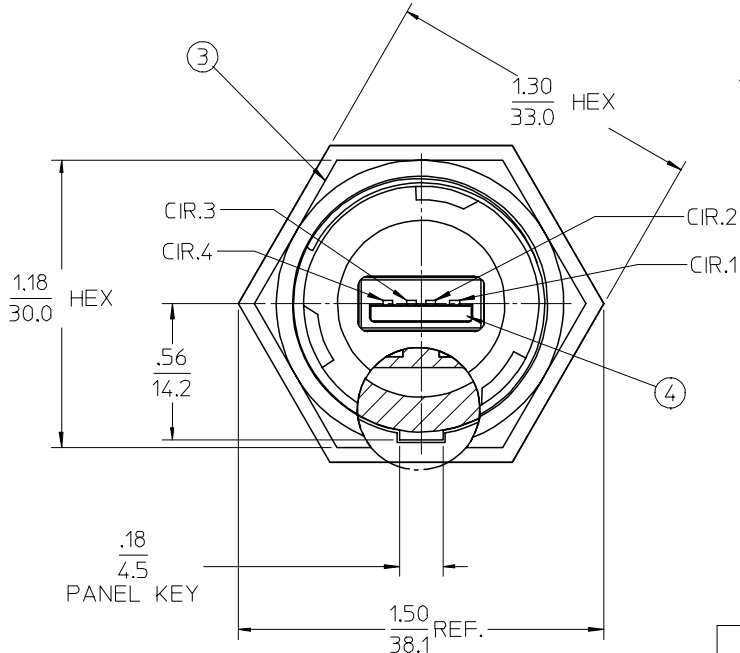
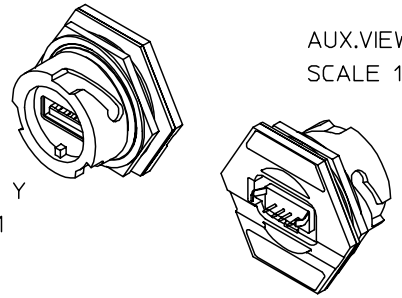

4	1	USB-A RECEPTACLE, PCB TYPE	VENDOR SPEC.	NI PLATED CONTACTS
3	1	LOCK-NUT	PA	BLACK
2	1	GASKET SEAL	NEOPRENE	BLACK
1	1	USB RECEPTACLE, PANEL MOUNT	PBT	BLACK
ITEM	QTY	DESCRIPTION	MATERIAL	FINISH

RELEASE TO BUILD
 EC NO: ETC2006-0180
 DRWNR: STONE 2006/01/11
 CHKDR: DEROSS 2006/01/12
 APPR: DEROSS 2006/01/13

QUALITY SYMBOLS
 ▽=0
 ▽=0

GENERAL TOLERANCES (UNLESS SPECIFIED)	
	mm INCH
4 PLACES	± .005 ± .002
3 PLACES	± .005 ± .002
2 PLACES	± 0.13 ± .01
1 PLACE	± 0.25 ± .01
ANGULAR ±1/2°	

DIMENSION STYLE IN/MM
 DRAWN BY R. STONE DATE 05-11-21
 CHECKED BY R. DEROSS DATE 06-01-05
 APPROVED BY R. DEROSS DATE 06-01-05
 MATERIAL NO. 847290009

SCALE 2:1 DESIGN UNITS INCH
 TITLE RECEPTACLE, PANEL MT. USB-A, PCB STYLE
 MOLEX INCORPORATED
 DOCUMENT NO. SD-84729-004 SHEET NO. 1 OF 1

THIS DRAWING CONTAINS INFORMATION THAT IS PROPRIETARY TO MOLEX INCORPORATED AND SHOULD NOT BE USED WITHOUT WRITTEN PERMISSION